



Innovation Zed Ltd.

NovaUCD, Belfield Innovation Park,
Belfield, Dublin 4,
Ireland

REF

IC-Connect

IP22

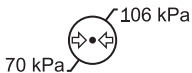
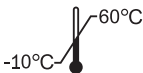

Thank you for using InsulCheck CONNECT. This User Manual provides important information to help you use your InsulCheck CONNECT properly. Before using the product, please read it carefully.

If you have any questions about this product, please:

- Consult our website www.innovationzed.com
- Email our Customer Support Team info@innovationzed.com



IMPORTANT

Read all instructions and warnings before use.

Innovation Zed only accepts responsibility for the equipment's safety, usability and performance if:

- the equipment is used in accordance with its intended use, and
- the equipment is used in accordance with the product documentation



Do not use InsulCheck Connect to make decisions about your injection regime.

Table of Contents

1	Introduction.....	6
1.1	Definitions	6
1.2	General description.....	6
1.3	Intended use.....	6
1.4	Intended Users.....	7
1.5	Normal use.....	7
1.6	Symbols.....	7
2	Description of the Device.....	10
2.1	Package contents	10
2.2	General safety instructions.....	10
2.3	InsulCheck CONNECT terminology.....	11
2.4	Insulin pen terminology.....	14
2.5	Supported pens.....	14
2.6	Performance	16
3	Operating instructions	16
3.1	First time use.....	16
3.2	Injection.....	19
3.3	Low dose injections	20
3.4	Checking battery status	21

3.5	Charging.....	22
3.6	Bluetooth® pairing.....	23
3.7	Maximum number of pairings.....	25
3.7.1	Clearing paired devices.....	25
3.8	Changing Pen.....	27
3.9	Factory reset.....	28
3.10	Powering off.....	29
3.11	Powering on.....	30
3.12	Cleaning and care.....	31
3.13	Long-term storage.....	32
3.14	Disposal.....	32
3.15	General safety advice.....	32
4	Troubleshooting.....	33
4.1	Injection not detected.....	33
4.2	Blinded sensor.....	34
4.3	Spillage.....	34
4.4	System error.....	34
4.5	Unsuccessful pairing.....	35
5	Display guide.....	36
6	Contact information.....	41

6.1	Support.....	41
6.2	Manufacturer	41
6.3	Warranty	41
6.3.1	Disclaimers	41
7	Technical specification.....	42
7.1	Specifications.....	42
7.2	Environment and operating conditions.....	43
7.3	Declarations.....	43

1 Introduction

1.1 Definitions

Device InsulCheck CONNECT

User Insulin pen user, Patient or Operator

1.2 General description

InsulCheck CONNECT helps you track your insulin injections. It can streamline your diabetes management by automatically logging injections into a diabetes management app. You can also easily see the time since last injection on the display, helping you to stay on top of your injection routine.

InsulCheck CONNECT is clipped-on to your insulin injection pen. Once mounted on the pen, it automatically detects when you dial-out a dose and perform an injection. The Device starts counting up the time after you have injected.

1.3 Intended use

InsulCheck CONNECT is a long-term secondary aid in diabetes management, by providing information about the timing of injections of insulin.



The timer on the InsulCheck CONNECT must NOT be used as the only indicator to decide when to inject insulin. You must rely on your own memory and common sense, your blood glucose level and other information you have to decide when to perform an insulin injection.

The Device is designed to be used in common domestic environments such as your home, office or school.

1.4 Intended Users

InsulCheck CONNECT is intended for insulin pen users who are familiar with the use of these pens.

InsulCheck CONNECT should NOT be used as the sole or main method of managing the timing of injections or by users who are unable to manage their treatment without the use of the Device.











The User must be able to safely use all functions of the Device







1.5 Normal use

InsulCheck CONNECT is mounted on the insulin pen by the user. The Device is on the pen when injecting. The time since previous injection is displayed on the display screen. Using Bluetooth® technology, data from the Device can be transferred to a connected app (e.g. smartphone app). Once mounted, the Device need not be removed from reusable pens. When used with disposable pens, once the insulin runs out, the Device is removed and mounted on a new disposable pen. InsulCheck CONNECT has a lithium-ion battery that is rechargeable when a low battery is indicated.

1.6 Symbols

The following table describes the meaning of the symbols used in the User Manual, the Packaging and the Label on the bottom of the Device.

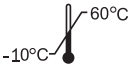
Symbol	Meaning
	This action is prohibited. User should read very carefully.
	Important information, warning or precaution. User should read carefully.
	Read User Manual before use.
	Name and address of manufacturer: Year-month of manufacture.
	Model number of the Device.
	Serial number of the Device.
	BLE (Bluetooth [®] Low Energy) name of the Device.
	Rating of the USB charger.
	Do not dispose as normal household waste. Dispose separately as Electronic Equipment waste.

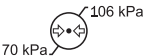
Symbol	Meaning
	<p>The Device Complies with Medical Device Directive 93/42/EEC.</p>
	<p>Do not use the Device if packaging is damaged or opened.</p>
<p>IP22</p>	<p>Degree of enclosure protection.</p>
	<p>Protect Device from moisture.</p>
	<p>Avoid using the Device under direct sunlight.</p>
	<p>Range of temperature (upper and lower limit) to which the Device can be safely exposed to during transportation and storage.</p>
	<p>Range of humidity (upper and lower limit) to which the Device can be safely exposed to during transportation and storage.</p>
	<p>Range of atmospheric pressure (upper and lower limit) to which the Device can be safely exposed to during transportation and storage.</p>

2 Description of the Device

2.1 Package contents



Included in the box is:

- InsulCheck CONNECT (Device)
- USB charging cable (Charger not included)
- Documentation (User Manual)

2.2 General safety instructions



Do not use the Device if packaging is damaged or opened



Do not use InsulCheck CONNECT if any part looks broken or damaged

InsulCheck CONNECT supports a variety of insulin pens with each Device designated to work with only one specific pen model (see section 2.5 for supported pens). InsulCheck CONNECT cannot detect that it is fitted on a wrong pen.



Before using, please check that you have purchased the Device designated for the model of pen you use.



It is your responsibility to ensure that you are using the correct Device with your pen. Consult your healthcare provider if you are unsure which insulin pen model you are using.

2.3 InsulCheck CONNECT terminology

The following images describe the key components of Insulcheck Connect.

- ① **Display screen** – Timer and other information is displayed on it.
- ② **Charging indicator** – Displays the charging status.
- ③ **Touch button** – Used to turn on the display screen. Both areas labelled 3a and 3b are part of the same touch button.
- ④ **Sleeve** – The sleeve can only be fitted properly on a specific pen model.
- ⑤ **Dose** – indicator window (in the sleeve).
- ⑥ **Dust Cover** – Protects the charging inlet.

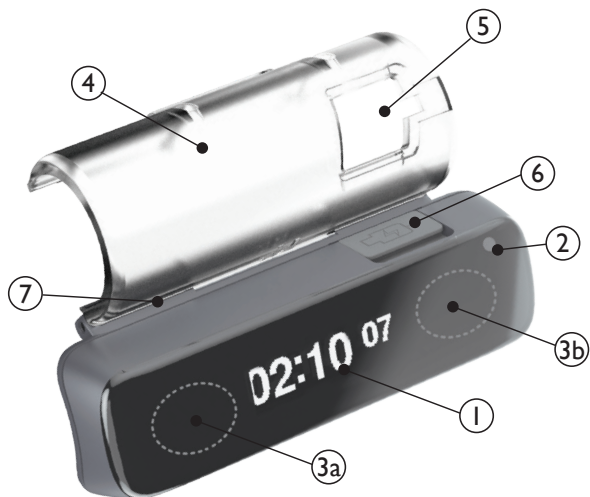

- ⑦ **Hinge mechanism** – Simplifies mounting of the Device on a pen.
- ⑧ **Reset button** – Hole for accessing the reset button using a paperclip or similar.
- ⑨ **Bottom label** – Carries Device identification and other important information.
- ⑩ **Mounting mechanism** – Press (click) together to fasten. Push down the clasp to release.
- ⑪ **Optical sensor** – Senses the change in position of the dose knob on the insulin pen.

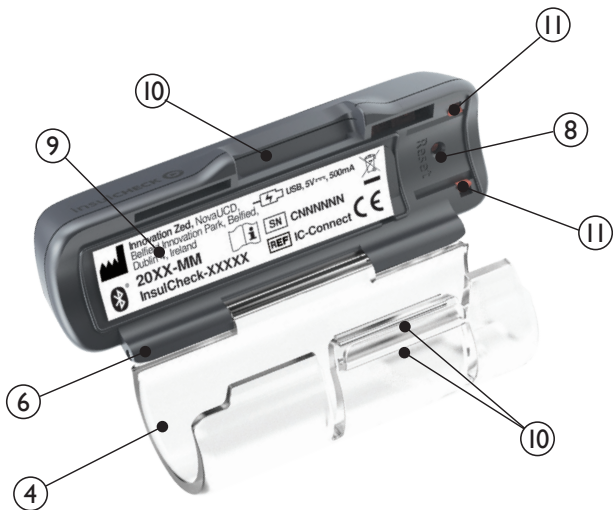

2.4 Insulin pen terminology

- ⑫ **Dose-knob** – the knob at the end of the insulin pen which is dialled to adjust the desired dosage of insulin.
- ⑬ **Dose-indicator** – the number of dialled-out insulin units. After mounting the InsulCheck CONNECT on a pen, the dose-indicator is visible through the window in the sleeve.

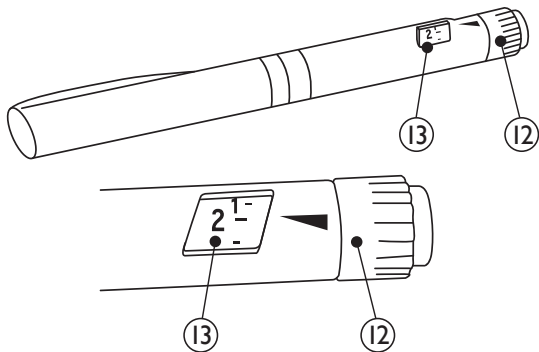

2.5 Supported pens

InsulCheck CONNECT is clipped onto the insulin pen using the sleeve, hinge mechanism and mounting mechanism.

The unique design of the sleeve means that the Device will only fit properly and operate correctly on the designated model of pen.

The abbreviation for the pen name the Device is designated for, is embossed on the sleeve.

The following table provides a list of pen models supported by InsulCheck CONNECT together with their abbreviations. The

detection threshold (i.e. the lowest dose injection the Device can detect) for each pen model is also given in the table. For information on how to handle dose units below this threshold, please see section 3.3.

Pen model	Abbreviation	Detection threshold
FlexPen® by Novo Nordisk Disposable pen	FP	3 dose units
SoloSTAR® by Sanofi Disposable pen	SS	2 dose units
KwikPen® by Lilly Disposable pen	KP	2 dose units
NovoPen® 5 by Novo Nordisk Reusable pen	NP5	2 dose units
Toujeo® SoloSTAR® by Sanofi Disposable pen	TSS	3 dose units
Savvio® by Lilly Reusable pen	HPS	3 dose units
NovoPen® 4 by Novo Nordisk Reusable pen	NP4	2 dose units
LUXURA® by Lilly Reusable pen	HPL	3 dose units
ClikSTAR® by Sanofi Reusable pen	CS	3 dose units

2.6 Performance

When the operating instructions, safety regulations and care requirements are properly followed, InsulCheck CONNECT will continue to automatically detect and record injections, display the timer, respond to tapping of touch button, recharge and transfer data to connected apps, as described in this manual during its service life.



Do not to use the Device if you observe a deterioration in any of these functions.

A decrease in charging interval can be expected due to normal battery degradation.

Contact our customer support team at info@innovationzed.com if the Device does not behave as specified in this manual, especially if proper screens are not displayed or the detection threshold increases.

3 Operating instructions

3.1 First time use

1. Peel off the labels

a. First from underneath the Device and then from the touch area and display.

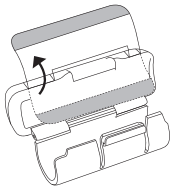

-  Part of this label prevents accidental powering-on of the Device during shipping. The label must be completely removed for the Device to function properly.

b. Then from the dose-indicator window

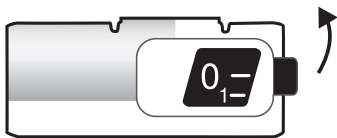

2. Mount the Device on your injection pen

- Align the dose-indicator window on the sleeve with the dose-indicator on the pen
- Check that the optical sensor is positioned near the dose-knob
- Push the sleeve onto the pen
- Press (click) together the mounting mechanism to fasten the Device on the pen

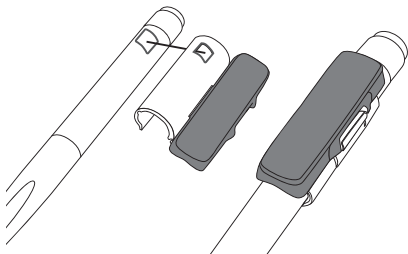

3. The Device powers on and the InsulCheck insignia is displayed



4. Then, the mounted on pen animation is displayed



5. Then, the dashed timer is displayed since no injection has been detected

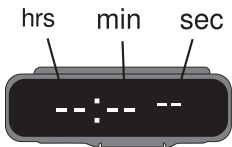

To save power, the screen will turn off after a few seconds. The Device remains powered on and keeps sensing.

3.2 Injection

1. Dial out dose

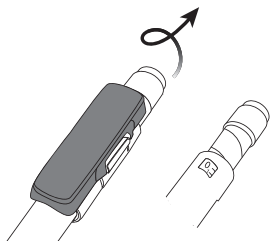

2. The timer stops counting up

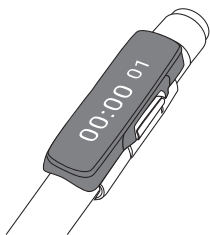

3. Perform the injection according to your therapy

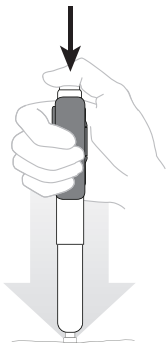

4. The timer resets due to the new injection and starts counting up

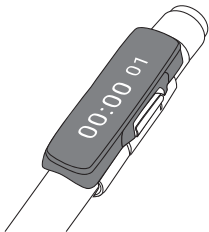



3.3 Low dose injections

Depending on the pen model, the Device cannot detect injections for doses below 2 or 3 units.

To make sure that injections are detected for doses below these thresholds:

1. Dial out a higher dose, for example 6 units. This will trigger the dose-knob sensing.
2. Dial the dose-knob back in to the actual low dose to be taken (e.g. 1 or 2 units) and then complete the injection.

 InsulCheck CONNECT does not detect actual injections. Its operation is based on sensing the changes in the position of the dose-knob when the user interacts with it during injections

 Playing or "fiddling" with the dose-knob of the pen is not allowed when the Device is mounted on the pen. Such unwanted actions, for example, dialling out and then in a dose without injecting, can cause the Device to display and record incorrect timing information.

3.4 Checking battery status

1. Tap the touch button to turn on the screen and activate Bluetooth[®]

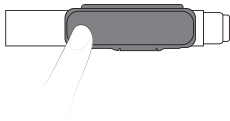

2. If the battery is low, a battery warning¹ is displayed for a few seconds



Keep your Device charged for smooth operation. Your injection time

¹Refer to the display guide in Section 5

will be detected even after a battery warning is displayed, but it will shut down soon after the blinking critical battery warning.

3. Timer is displayed and is counting up time since previous injection, Bluetooth® is active



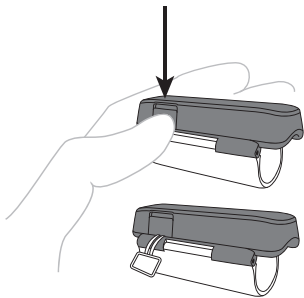

3.5 Charging

1. Open the dust cover protecting the charging inlet

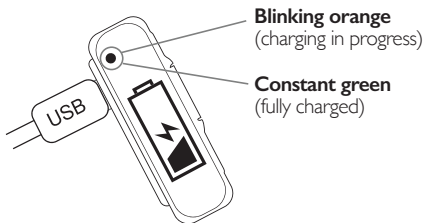

2. Connect the micro-USB charging cable



  **STOP. Do not inject while charging.**

3.6 Bluetooth® pairing

The information on time intervals between injections is stored on the Device for up to 30 days. You can transmit this information to your smartphone app via Bluetooth®

1. On your app or phone, activate Bluetooth® and scan for available devices



2. Tap the touch button to turn on the screen

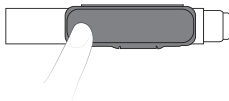

3. On the app or phone, select the Device from the list of available devices. The **BLE name** of your Device is written on the **label** on the **underside** of the Device and also on the **packaging**



Select BLE
name of
Device

4. Wait for the Device to display the passkey



5. Type the passkey into the prompt on your app or phone



Type the
passkey

a. If pairing is successful, an animation of a closed padlock will be displayed



- b. If pairing is unsuccessful, a padlock crossed by a blinking bar is displayed



3.7 Maximum number of pairings

InsulCheck CONNECT can be paired with a maximum of 3 different client devices (e.g. different smartphones or apps). When you pair with a fourth client device your InsulCheck CONNECT will automatically drop the first client device you connected with to accommodate the new client. You can clear all paired devices.

3.7.1 Clearing paired devices

1. Unmount the Device from the pen

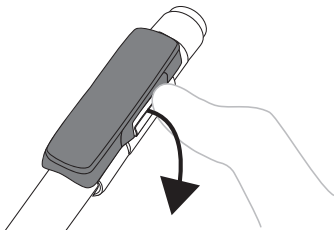

2. Turn the Device around so that the hole for accessing the reset button is exposed

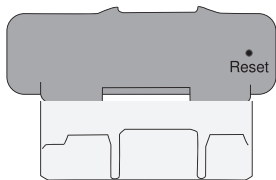

3. Push the reset button with a paper clip or similar tool for less than 3 seconds

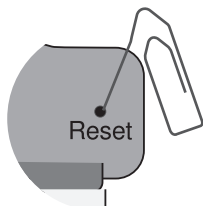

4. After the pairing data is cleared, the animation of an opening padlock is displayed on the screen



Pushing reset button for more than 10 seconds will trigger a factory reset.

3.8 Changing Pen

1. Open the clasp and remove the Device from the current pen

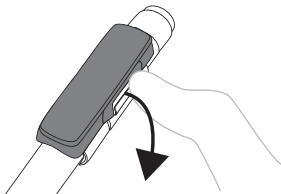

2. When the clasp is opened, the unmounted from pen animation² is displayed on the screen

3. Mount the Device on your new injection pen

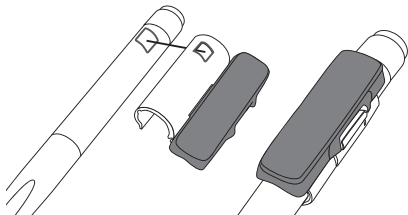

4. If the Device is correctly mounted, the mounted on pen animation is displayed



²Refer to the display guide in Section 5

5. After the change, the timer continues to count up the time

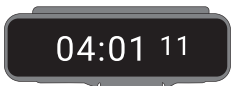

3.9 Factory reset

All the data stored in the InsulCheck CONNECT memory as well as the pairing data can be deleted by doing a Factory Reset. InsulCheck CONNECT also reboots as a result of a factory reset.

1. Unmount the Device from the pen

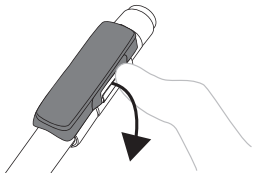

2. Turn the Device around so that the hole for accessing the reset button is exposed



3. Push the reset button with a paper clip or similar tool and keep it pressed for more than 10 seconds

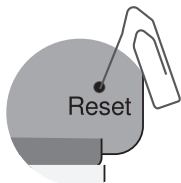

4. The Device reboots and the InsulCheck insignia is displayed confirming that a factory reset has been triggered



3.10 Powering off

To power off your InsulCheck CONNECT;

1. Unmount the Device from the pen

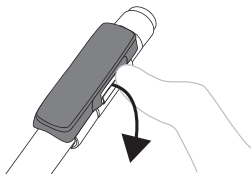

2. Turn the Device around so that the hole for accessing the reset button is exposed



3. Wait for the screen to turn off

4. Tap the touch button to turn on the screen

5. Push the reset button with a paper clip or similar tool and keep it pressed for more than 20 seconds. The screen must remain on during this time

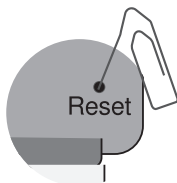

6. After about 20 seconds the screen will turn off. If the Device is powered off, tapping the touch button will not turn on the screen



Make sure that the screen stays on during the reset button press for powering off.







3.11 Powering on

A powered off device can be powered on by the following methods:

- Connecting the Device to a charger
- Mounting the Device on a pen
- Clicking the sleeve (without pen) to engage the mounting mechanism

3.12 Cleaning and care

Clean your InsulCheck CONNECT by wiping it gently with a clean cloth lightly moistened with water. The cloth should not leave any water droplets on the surface of the Device.

-  Do not use any other liquids or solvents when cleaning the Device.
-  Make sure that no excessive dust, moisture, water or other agent builds-up on the optical sensor of the Device. Clean the optical sensor with a clean dry or slightly moistened cloth if any build-up appears.
-  Keep the Device within the specified temperature, humidity and atmospheric pressure ranges.
-  Do not expose the Device to open flame or put it too close to a heated surface.
-  Never pour water or other liquids on the Device. Never submerge the Device in water or other liquids. If this occurs, dry off quickly with a clean cloth.
-  Do not store the Device in a freezer.
-  Do not use the Device if abnormal heat, odour, discolouration, deformation, or other abnormal condition is detected during use, charging or storage

3.13 Long-term storage



If you decide not to use your InsulCheck CONNECT and wish to store it for future use:

1. Fully charge the battery.
2. Power off the Device (follow steps in section 3.10).
 - a. Do not mount the Device on a pen after powering off.
 - b. Do not click the sleeve (without pen) to engage the mounting mechanism - this will power on the Device
3. Store the Device at temperatures between -10 to 60°C (14 to 140°F) in Relative Humidity of 45 – 85%, at altitudes of <3000 m (<9840 ft.) and at normal Atmospheric Pressure



3.14 Disposal

At the end of the Device's service life it should be disposed as electrical waste according to local regulations.

3.15 General safety advice

-  Only use a certified 5V USB charger from a legitimate supplier with the Device (for example, CE marked etc.) to minimise the risk of electric shock and damage to the Device.
-  In the unlikely event of deterioration in the functionality of nearby equipment in the presence of InsulCheck CONNECT, remove the Device from the vicinity.
-  To avoid degradation in performance of InsulCheck CONNECT, radio equipment (such as phones, computers, wireless devices, antennas, antenna cables etc.) should not be used closer than 30 cm (12 inches) from the Device. This distance should also be observed

for the charging cable if it is plugged-in to the Device.

-  To reduce the risk of interference from outside sources, avoid using InsulCheck CONNECT near strong sources of electromagnetic radiation (e.g. CT, MRI, X-ray equipment etc.).
-  To ensure proper operation of the Device, avoid using it adjacent to or stacked with other electrical equipment.
-  Do not use the Device in oxygen rich environments

4 Troubleshooting

4.1 Injection not detected

The main cause for injections not detected is that the optical sensor in the Device is not working properly. The following can be helpful in fixing the issue:

- Make sure that the Device is designated for the pen model it is mounted on (see section 2.5).
- Make sure that the Device is fitted and positioned correctly on the pen i.e. the optical sensor is positioned close to the dose-knob after mounting (see section 3.1).
- Press the mounting mechanism together to ensure that the Device is properly mounted on the pen. The 'mounted on pen' animation appears when the Device is properly mounted (see section 3.1).
- Make sure that there is no build-up of dirt etc. on the optical sensor (see section 3.1.2 for cleaning instructions).
- If it is still not working, unmount and re-mount the Device on the pen (see section 3.8).

- If injections are still not detected contact our Customer Support Team at info@innovationzed.com

4.2 Blinded sensor

The optical sensor of the Device is blinded when exposed directly to intense light (e.g. bright sunlight) and cannot detect the activity of the dose- knob. The screen will display the blinded sensor warning.



If this happens, take the device out of the intense light until the warning is no longer displayed. The Device can now be used normally.

4.3 Spillage

Should an accident occur exposing InsulCheck CONNECT to a liquid (e.g. a cup getting knocked over causing spillage), remove it from the pen, dry it by wiping gently with a clean dry cloth, and set the Device aside for several hours before resuming its use.



The Lithium-Ion battery should not be exposed to water or other liquids.

4.4 System error

If the InsulCheck insignia is displayed periodically on the screen, this means that the Device has a repeating system error which it cannot recover from. If that happens, stop using the Device and contact our Customer Support Team at info@innovationzed.com



Insignia displayed periodically

4.5 Unsuccessful pairing

There are a number of reasons for an unsuccessful Bluetooth® pairing.



The most common reasons are:

1. It may be that the passkey was mistyped into the app or phone. Repeat the process or follow the instructions on your phone or app.
2. Check that your smartphone or app supports connection to your InsulCheck CONNECT
3. The Bluetooth® functionality is implemented in different ways by mobile device manufacturers and by app developers. There may be a compatibility issue which cannot be resolved.

If you still cannot pair with the desired client device, please contact our Customer Support Team at info@innovationzed.com

5 Display guide

Graphic

Reference



insulCHECK

InsulCheck insignia is displayed on the screen for a few seconds after the Device is powered on. It is also displayed after a factory reset. The insignia is generally followed by displaying the Firmware Version on the Device for a few seconds.



02:10 07

When the screen is turned on, the timer is displayed on it. The timer counts up the time since the previous dialling-in of the dose- knob (during injection) was detected. The timer displays the time since the previous injection.



-- : -- -- --

If no injections have been detected, the screen displays dashed lines.



02:10 07

Timer value up to 24 hours (1 day) is displayed in HH : MM^{SS} format (Hours : Minutes Seconds).



1 02:10

If the time since previous injection is more than 1 day, the number of days is shown within the calendar symbol followed by HH : MM (Hours : Minutes).

Graphic

Reference



After an injection, the timer resets to 00 :00⁰⁰ (Hours : Minutes Seconds) and starts counting up.



When the screen is turned on, if the battery is low, the low battery warning is displayed for a few seconds before the timer is displayed.

 Charge the Device fully if a battery warning is displayed.



When the battery is very low, a blinking critical battery warning is displayed for a few seconds before displaying the timer.

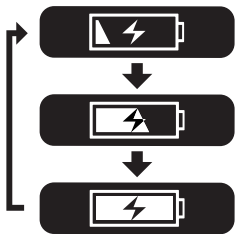

When a charger is connected to the Device and the battery is not fully-charged, this animation is displayed for a few seconds before displaying the timer.



Charging is finished when the battery is fully charged. This graphic is displayed for a few seconds before displaying the timer.

Graphic

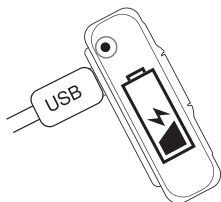

Reference

The charging indicator will light when a charger is connected to the Device. Blinking orange indicating charging is in progress. Constant green indicates the battery is fully-charged and charging is finished.

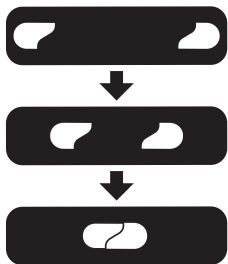

When InsulCheck CONNECT is properly mounted on the pen it is designed for; the sleeve clicks, the mounting mechanism is engaged, the display shows the two closing components on the screen.

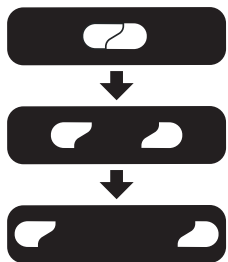

Unmounting a properly mounted Device disengages the mounting mechanism and the two opening components is displayed on the screen.

Graphic



Reference

When pairing InsulCheck CONNECT to an app (e.g. smartphone app), a passkey is displayed on the screen. Enter the passkey displayed on the Device in your app to complete the pairing process.

 The passkey is only valid for a short time. If it is not entered in the app, it will disappear, and the pairing sequence must be repeated.



A closing padlock is display indicates successful pairing.



If pairing is unsuccessful a padlock crossed by a blinking bar is displayed.

Graphic

Reference



an opening padlock is displayed when attempting to clear the pairing data of the Device.



When the Device detects (any activity) movement of the dose knob during charging, a USB connector crossed by a blinking bar is displayed.

 **STOP. Do not inject while the device is charging**



The optical sensor of the Device can be blinded when exposed directly to intense light (e.g. bright sunlight) and cannot detect the (activity) movement of the dose- knob. When the screen is turned on and the sensor is blinded, the blinded sensor warning is displayed.

6 Contact information

6.1 Support

Web: www.innovationzed.com

Telephone: +353 (0)1 901 0243

Email: info@innovationzed.com

6.2 Manufacturer

Manufactured for Innovation Zed Ltd., NovaUCD, Belfield Innovation Park, Belfield, Dublin 4, Ireland By Scandinavian Healthcare Ltd. Taiwan

6.3 Warranty

For the terms and conditions of the warranty, please see the separate warranty card (included in the package or provided by the local distributor).

6.3.1 Disclaimers



The manufacturer is not responsible for any problems, damages or malfunctions arising from unforeseeable circumstances.



Modification and taking apart the Device is not allowed and may interfere with performance and safety.

7 Technical specification

7.1 Specifications

Name	InsulCheck CONNECT
Model no.	IC-Connect
Service life	2 years
Typical operation time	Supports continuous use. Typical operation time - five activations per day of 30 seconds each
Dimensions With mounting mechanism engaged	62 x 22 x 28 mm
Weight	20 grams
Accuracy of the timer Time since previous injection	15 second drift over one day (24 hours)
Data Storage	Approximately 30 days
Battery	Li-ion rechargeable battery, 3.7VDC (nominal), 40mAh, 300 recharge cycles
Power consumption	Max. 105 mWatt
Charger rating	USB 5VDC, min. 500mA C
Maximum internal working voltage	9VD

Radio	Certified Bluetooth® Module FCC ID: WAP4008 Tx & Rx freq.: 2400 – 2800 MHz Max. Tx power:3dBm
--------------	--

7.2 Environment and operating conditions

Normal operation	0 to 40°C (32 to 104°F), 45 – 85% RH
Transport and storage	-10 to 60°C (14 to 140°F), 45 – 85% RH
Charging	10 to 45°C (50 to 113°F), 45 – 85% RH
Altitude & Atmospheric Pressure	<3000 m (<9840 ft.) & 70 – 106kPa
Degree of enclosure protection	IP22
Vibration/ Shock/ Bump/ Drop / Free fall	Transportation worldwide by air, road, ship and train

7.3 Declarations

This device has been tested to meet the electrical and safety requirements of:

Medical Electrical Equipment

EN61000-6-3 : 2007+A1:2011, EN61000-6-1 : 2007, EN61000-4-2 : 2008, IEC 61000-4-3 : 2006+A1:2007+A2:2010, IEC 61000-4-8 : 2009, EN 62479:2010, EN5514-2:1997+A1:2001+A2:2008

RoHS Directive 2011/65/EU - IEC 62321:2008

Electromagnetic compatibility

CFR 47: part 15 sub part b (Radio Module FCC ID:WAP4008 see FCC NOTICE below)

ICES 003of 2016; (IC (Industry Canada) Radio Module IC ID: 7922A-4008 see note below)

ANSI 63.4 of 2014

RED – Radio Equipment Directive 2014/53/EU – pre-certified by supplier

FCC (USA) - Radio Module FCC ID: WAP4008 FCC NOTICE:

This Device complies with Part 15 of the FCC Rules. The Device meets the requirements for modular transmitter approval as detailed in FCC public Notice DA00-1407. Transmitter Operation is subject to the following two conditions:

- (1) This Device may not cause harmful interference, and
- (2) This device must accept any interference received, including interference that may cause undesired operation.

IC (Industry Canada) Radio Module IC ID: 7922A-4008

The Device meets the requirements for modular transmitter approval as detailed in RSS-GEN. Operation is subject to the following two conditions:

- (1) This Device may not cause harmful interference, and
- (2) This Device must accept any interference received, including interference that may cause undesired operation.